

Article number: 20285B16B122SW

Description: E+G Swivel clamp connector joint
GN285-B16-B12-2-SW

Measures

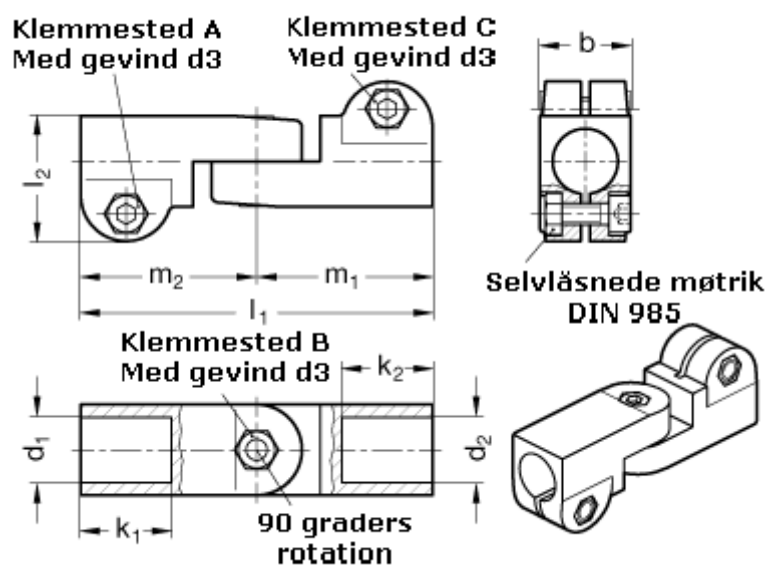

$b = 25$	$m_1 = 48.5$
$d_1 = B16$	$m_2 = 48.5$
$d_2 = B12$	
$d_3 = M 6$	
$k_1 = 25$	
$k_2 = 25$	
$l_1 = 97$	
$l_2 = 34.5$	